



Boston Area Windows Server User Group
April 2010

Hey Jack, don't you have a new job?



- **Yes, unbelievably, my job is better than ever.**
- **After working in our outstanding Support Engineering team for the past few years I have moved into a new role, Community Development Manager.**
- **This means things like THIS are officially part of my job!**
- **B-Sides events, speaking, partner development, and more.**
- **So BUY STUFF so I can keep doing it.**
- **Just Kidding.**
- **Well, not entirely.**

Company Profile



- **Founded 2000**
- **170 employees**
- **Headquarters in:**
 - Boston (USA)
 - Karlsruhe (Germany)
- **Worldwide Offices**
- **> 2500 partners & resellers worldwide**
- **24/7 Service**
- **Astaro protects more than 100,000 networks for 47,000 customers in over 60 countries**



Our Business



Astaro is **a leading supplier of All-In-One Internet Security Appliances**
for **small to medium sized companies and organizations**
requiring **integrated products for Email, Web and Network Security that are cost efficient and easy-to-use.**

In contrast to **suppliers of single- or other multi-function products for internet security**

Only Astaro offers **easy-to-use All-In-One security gateways with complete enterprise-class functionality specifically designed for SMEs**

Integration is Key

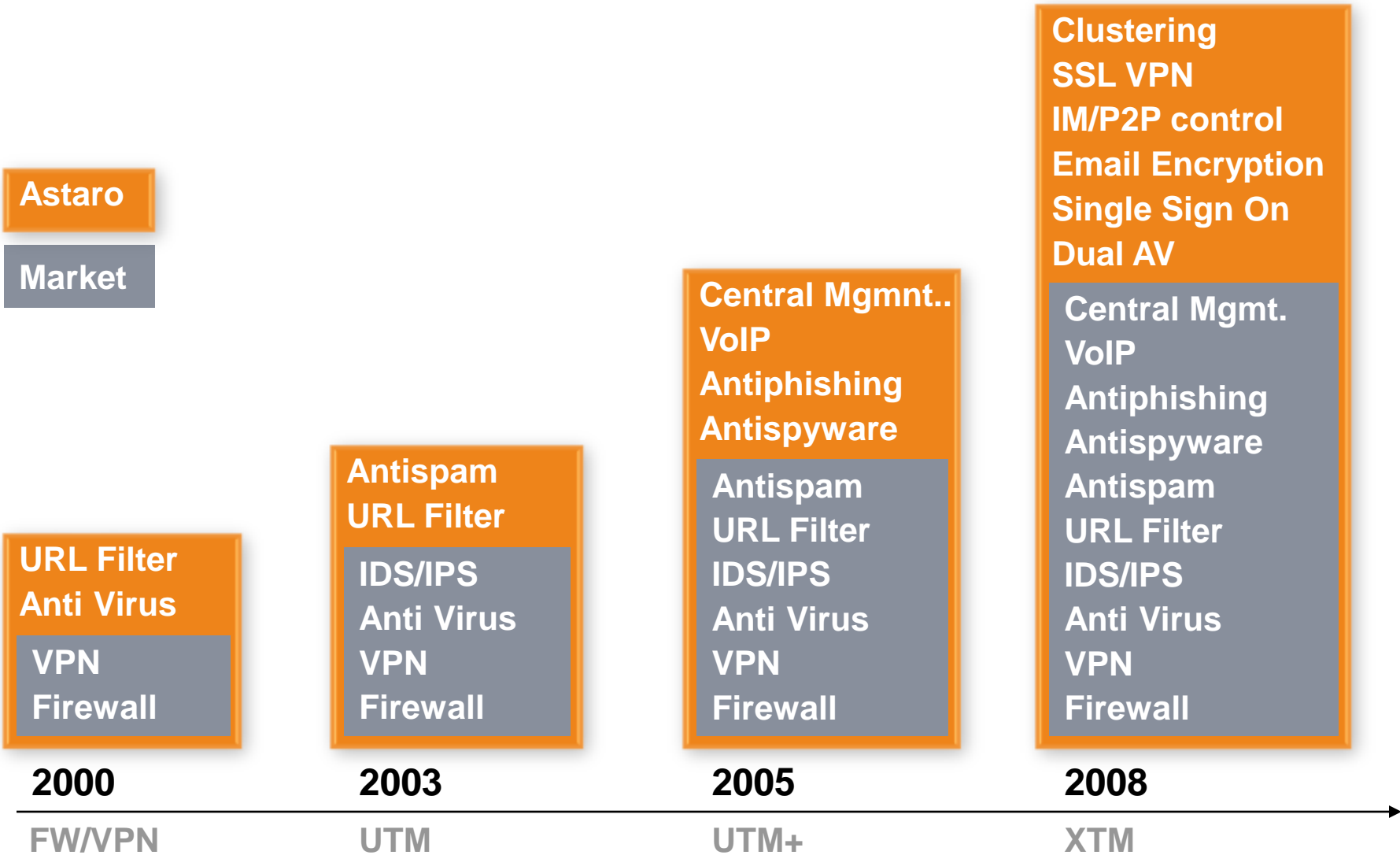

The Astaro All-In-One Approach



Flexible Deployment



**Integration of
Complete Email, Web
& Network protection**



All-In-One Appliance



**Browser-based
Unified Management of
All Applications**



**Automatic
Firmware & Pattern
Updates**

**Centralized
Management &
Reporting**



**Networking-Features
for High Availability
and Load Balancing**

Successful Customers



Awards

Technology Innovation of the Year Award 2008

„superior performance“

(Frost & Sullivan)



2008 Editor's Best Award

„competitive advantages, value to the customer“

(Windows IT Pro)



Top 100 Innovator 2008

„exceeding creative and innovative research and development“

(Compamedia)



3x Best of the Year Award 2x Editor's Choice

„To call Astaro's Appliance just a UTM would be a major understatement.“

(SC Magazine)



PC Praxis Testsieger

„technically outstanding“

(PC Praxis)



2x Product of the Year

„Among the array of contenders, one product managed to stand out.“

CRN Magazine



Industry recognition as finalist:

Best Anti-Malware Solution

Best SME Security Solution

Best Enterprise Firewall

Best IPSEC/SSL VPN Solution

Winner!

“Best SME Security Solution”



Astaro Security Gateway

Comprehensive Email, Web & Network Security



Essential Firewall

Stateful Firewall
Network Address Translation
PPTP/L2TP Remote Access



Optional
Subscriptions:

Network Security

Intrusion Prevention
IPSec/SSL VPN
IPSec/SSL Remote Access

Mail Security

Anti Spam & Phishing
Dual Virus Protection
Email Encryption

Web Security

URL Filter
Antivirus & Antispyware
IM & P2P Control

Enterprise-class Security designed for SMEs

Deployment Models

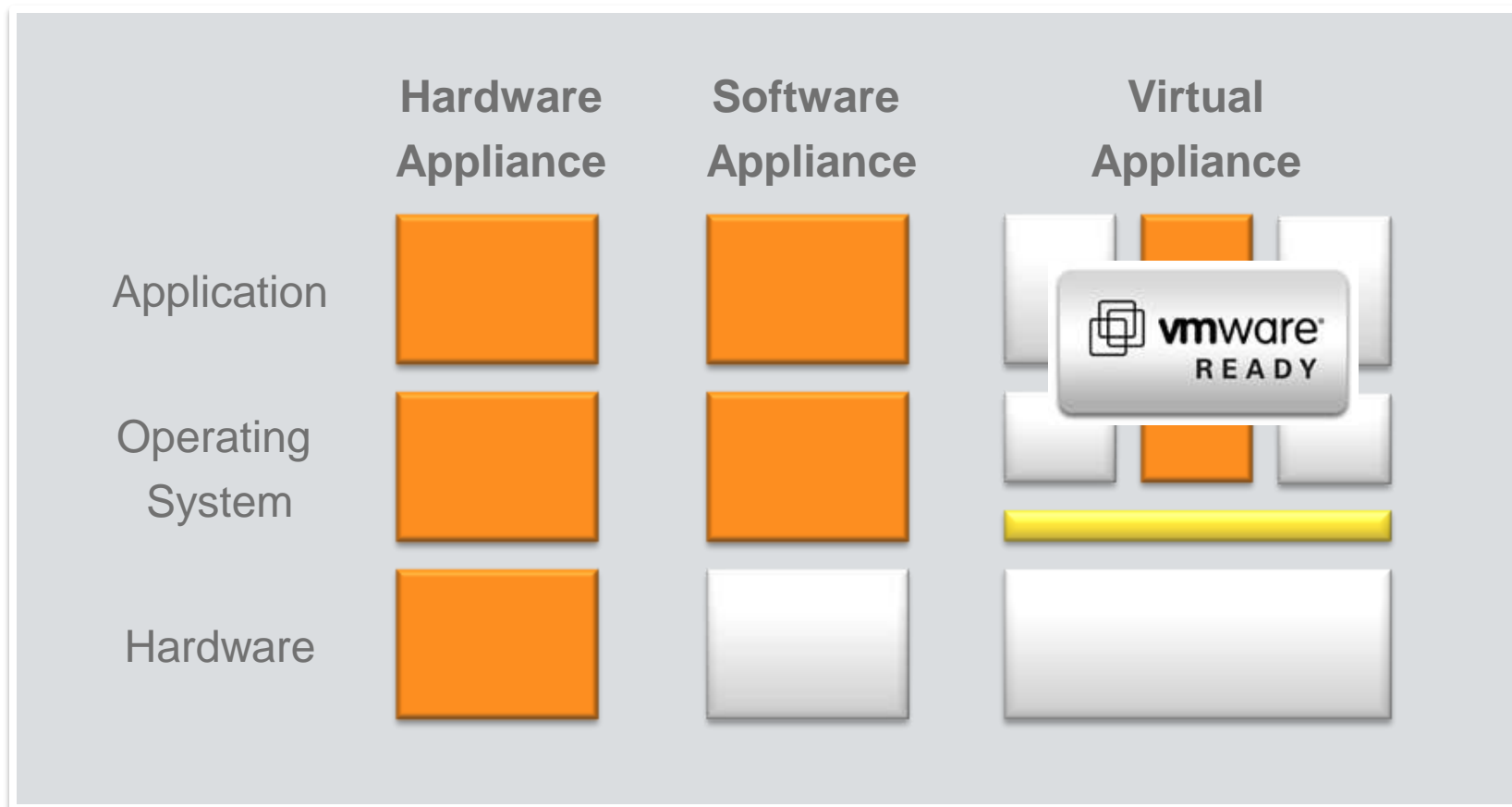

First UTM Appliance that passed VMware validation program

Free Evaluation options

Astaro Security Appliances
FREE for 30 Days.



[Get Yours Now](#)



Have an idea? Let us know...



How Would You Change It? **BETA**



Astaro Gateway Feature Requests Forum

Log in or Sign up | English

Welcome to our official feedback forum. Do you have an idea? Do you recognize a good idea when you see one? We want to hear from you!

I suggest you ...

- enter your idea (new feature, usability improvement, etc) -

Search

top hot new 36 accepted ideas 42 completed 125

434 votes

vote

HTTP Reverse Proxy

Add a Reverse proxy to ASG which is mainly requested for securing OWA as customers do not want to put it directly onto the internet. - some customers ask for Authentication prior allowing access - other customer want SSL-Offloading - third want Website security by preventing Cross site scripting... [more](#)

20 votes left!

[What happens if I run out?](#)

[Astaro Gateway Feature Requests activity feed](#)

[Contact Support](#)



Categories

All Ideas

Astaro Security Gateway

Three Editions to choose from!



		 Essential Edition	 Professional Edition	 Home Edition
		Free for business use	Starting at 345	Free for home use
Period of Validity		Indefinite	30 Day Trial	Indefinite
No. of Protected Users /Computers*		Unlimited	Depends on purchase plan	Up to 50 IPs
Platforms Available		Software Appliance, Virtual Appliance	Hardware Appliance, Software Appliance, Virtual Appliance	Software Appliance
Networking	Internet Router	✓	✓	✓
	DNS /DHCP Server	✓	✓	✓
	WAN-link Balancer		✓	✓
Network Security	Firewall	✓	✓	✓
	VPN	PPTP, L2TP	PPTP, L2TP, IPSec, SSL	PPTP, L2TP, IPSec, SSL
	IPS		✓	✓
Web Security	Web Filter		✓	✓
	Anti Virus		✓	✓
	IMP2P Blocker		✓	✓
Mail Security	Spam Filter		✓	✓
	Anti Virus		✓	✓
	Encryption		✓	✓

Astaro Security Gateway

Products



Hardware Appliances

	ASG 110/120	ASG 220	ASG 320	ASG 425	ASG 525	ASG 625
						
Environment	Small networks	Medium networks	Medium networks	Large networks	Large networks	Large networks
10/100 Mbps Network Ports	4	8	4	-	-	-
Gigabit Network Ports	-	-	4	6 & 2 SFP	10 & 4 SFP	10 & 8 SFP
Max. recommended FW Users	10/50	150	350	1000	2500	4000
Max. recommended UTM Users	10/25	70	200	600	1300	2000

Software Appliance*

Runs on Intel-compatible PCs and servers



Virtual Appliance*

Runs in any VMware environment



*Pricing based #IPs/Users

Enterprise-Class Email, Web and Network Security designed for SMEs:

Net

- IPSec, SSL, PPTP and L2TP VPN support on all appliances
- One-Click Full IP SSL VPN with unlimited free clients
- Deep Inspection Packet Filtering with >7.500 rules

Mail

- Dual independent Antivirus Engines scan all SMTP & POP3-Mails
- Extensive set of enterprise-class spam detection capabilities
- Clientless Email Encryption (TLS, S/MIME, OpenPGP)

Web

- Dual independent Antivirus Engines scan all HTTP/S and FTP data
- Granular URL Access Control Policies supporting SSO
- User-based IM/P2P control, including skype blocking

Easy Management

GUI

- 7th Generation AJAX-featured GUI in 6 local languages
- Automatic pattern and system software updates
- Localized User Portal in 15 languages
- One-Click-Clustering with integrated load balancing
- Automatic Configuration Backup via email
- Easy integration with Active Directory and Exchange

Astaro Command Center



Centralized Management for Astaro All-In-One Gateways

Astaro Command Center

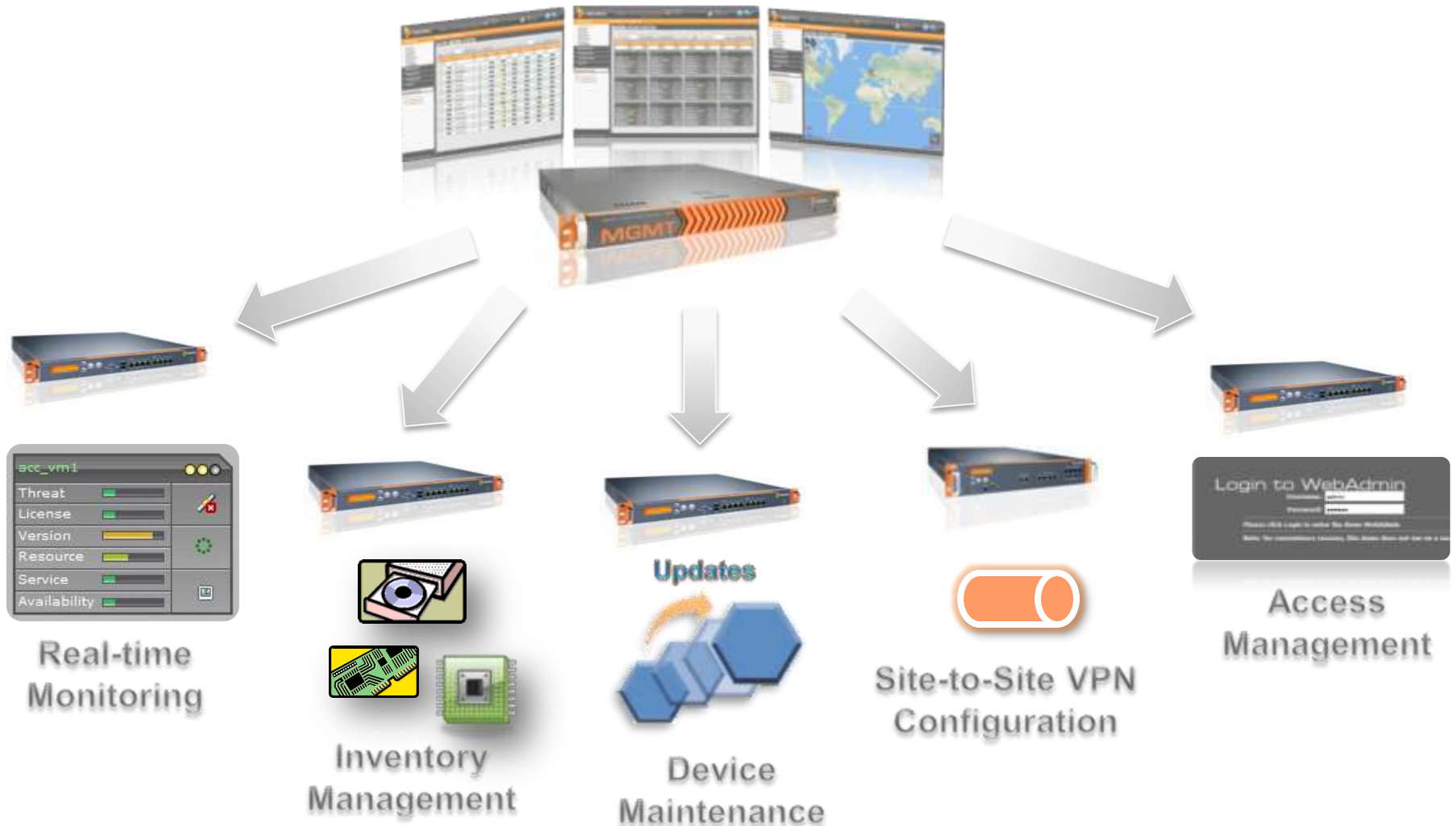

Astaro Command Center

Multi Client Deployment

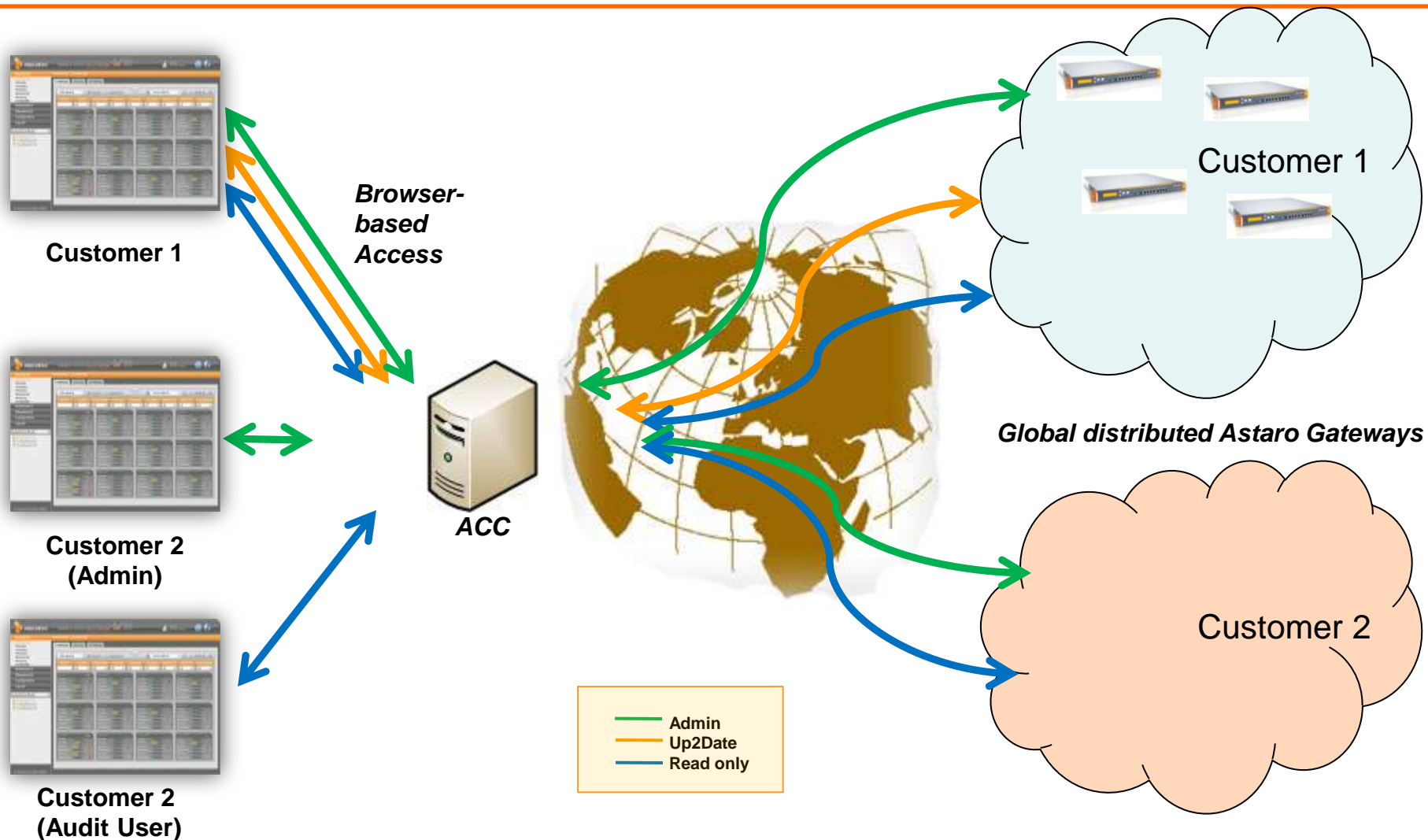

Astaro Command Center

Easy to use

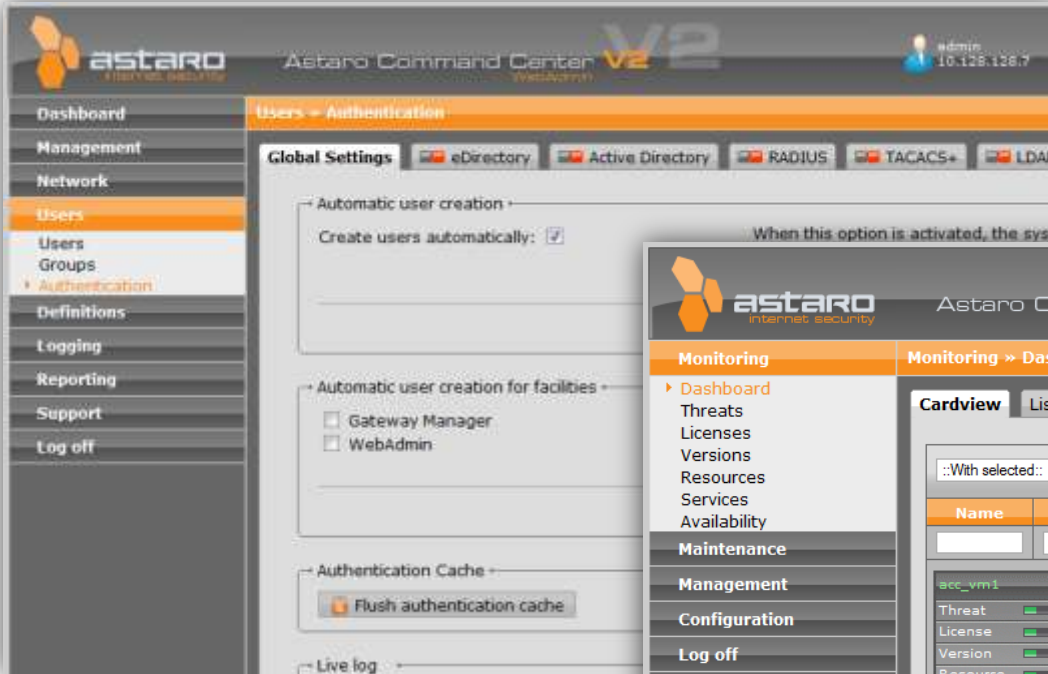

WebAdmin

ACC System Management



Gateway Manager

Device Management for individual customers

Astaro Command Center



Software Appliance*

Runs on Intel-compatible PCs and servers



Virtual Appliance*

Runs in any VMware environment



*Free of charge

WAN Link Balancing

Example Scenario 1

Dual lines, a Cable and a DSL.

Goals:

- All traffic from and to Mail/Webserver use the Cable.
- User surfing and other traffic out the DSL

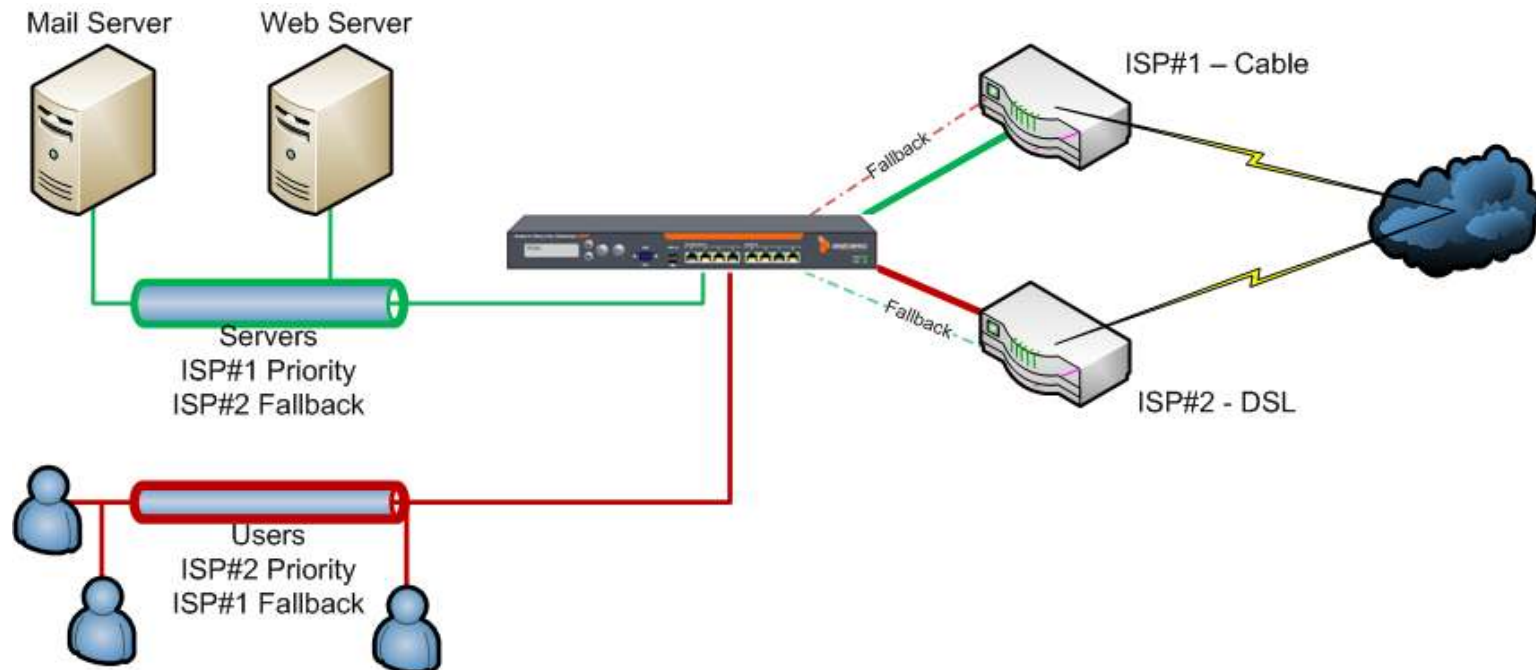

WAN Link Balancing

Example Scenario 2

Four Lines, 2 Cable and 2 DSL

Goal:

Balance all user activity automatically across multiple lines with failover, in order to save money using residential connections versus buying a more expensive, business-class circuit.

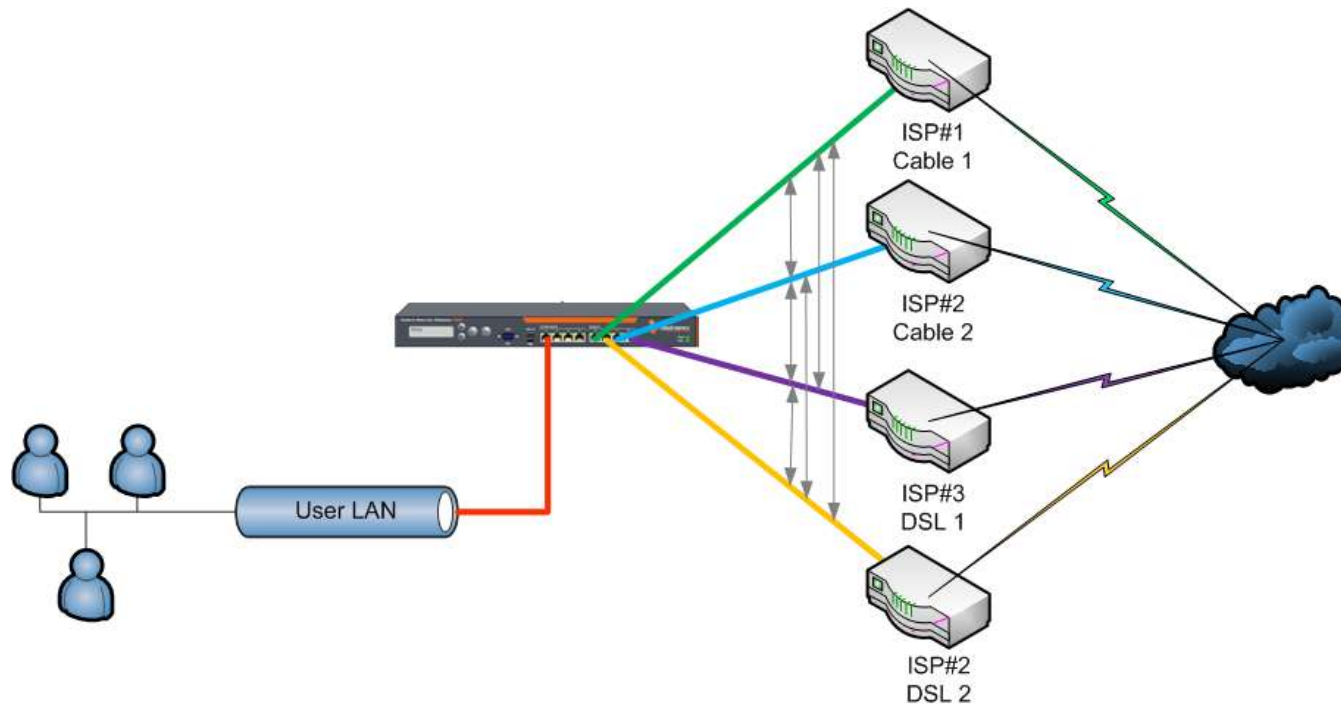



astARO
internet security

Simplifying Email, Web & Network Protection

internet security

New Product:
Code Name "Red"

Easy Installation

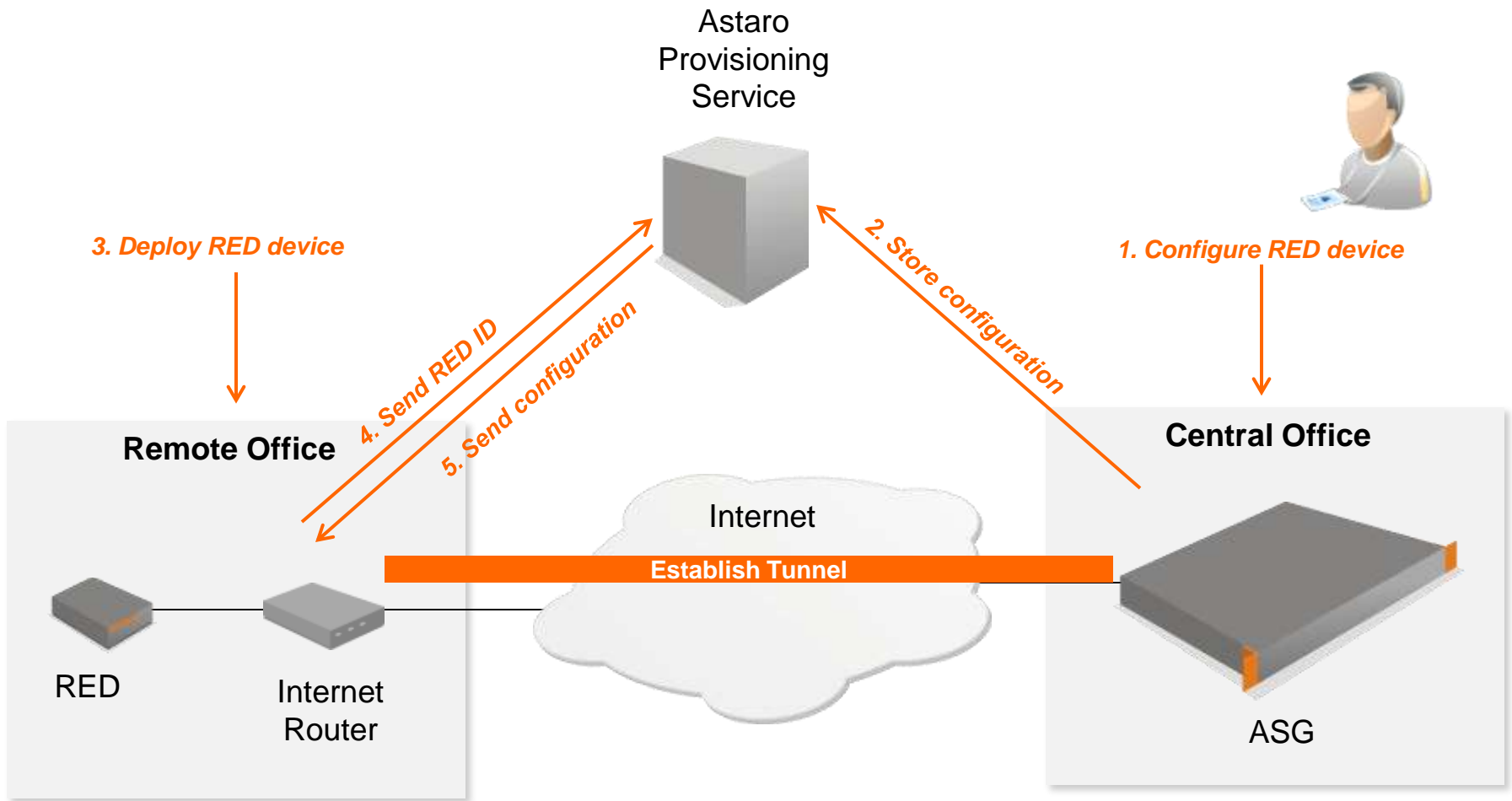

Key Features



- **All administration done via central ASG - no local configuration required – no GUI**
- **Central ASG automatically stores configuration files for RED devices on centralized provisioning server (hosted by Astaro)**
- **Retrieve IP address for local network via DHCP from central ASG**
- **Efficient Astaro-VPN-tunnel-technology**
- **>40 Mbit/s VPN-throughput by means of HW acceleration**
- **Integrated 4-Port Switch**
- **Moderate power consumption, <5 Watt**
- **No movable parts**



astARO
internet security

Simplifying Email, Web & Network Protection

internet security

New Product:

Astaro Security Gateway 8.0

New Linux Kernel

- **Improved hardware compatibility**
- **64-bit support**
- **Optimized RAM usage**
- **Better performance**
- **Support of paravirtualization**

New Base System

- **Suse SLES 11 based**

HTTP Reverse Proxy: Protection for Your Web Server

- **Web Application Firewall (WAF)**
 - Protection against Cross Site Scripting
 - Stops SQL Injection attacks
 - Protecting OWA, ActiveSync Sharepoint
- **SSL Termination**
- **URL Rewriting/Routing**



IPv6 Support:

- Dual stack supports IPv4 & IPv6
- DHCP/DNS for IPv6 addressing
- Tunnel support (6to4, Teredo, Tunnel Broker)
- Supported functionality:
 - Firewall
 - Intrusion Prevention
 - Web Security



VPN Activity Report:

- Overview of VPN usage
- Historical reports covering user/time
- Logging of user activities
- Termination of active connections

Auditing & Compliance Functionality:

- **Logging of configuration changes**
 - Who has changed what and when
- **Role-based Administration**
 - Separation of tasks and roles

Documentation of the Configuration:

- **Easily print the configuration**
- **Export of the entire device configuration**
- **Formats: Text, XML, HTML, PDF**
- **Meet compliance requirements**
- **Disaster recovery**

- **ASG V8.0 will be certified according to CC EAL4+ at the BSI**
- **Project start: Q2 2009**
- **Listed as being in certification: Q4 2009**
- **Certificate available: Q4 2010**

AxG V8 (Q2/Q3 2010 - Scope)

- **New Kernel**
 - Better HW compatibility
 - 64-bit support
 - Paravirtualization support
 - Less memory consumption, more performance
- **HTTP Reverse Proxy**
 - Web Application Firewall
 - SSL Offloading
 - URL Rewriting
- **VPN Activity Report**
- **Track Config Changes**
- **Printable Configuration**
- **Granular Admin Permissions**
- **IPv6 Support**
 - IPv4/IPv6 Dual Stack
 - 6to4
 - Tunnel Broker
 - Teredo
 - DHCP/DNS Support
 - IPS
 - IPSec
 - HTTP Proxy
- **30+ Additional Features...**



astARO
internet security

Simplifying Email, Web & Network Protection

Product Demos
Astaro RED
V8 Preview

Now, the hard-core sales pitch...



Remember the free stuff.



- **Free Home Use Licenses**
 - Really free, including all subscriptions.
 - Up to 50 IP addresses protected.
- **Free Commercial Firewall (Essentials) Licenses**
 - Unlimited protected IP addresses.
 - Basic firewall functions only.
- **Free ACC (Astaro Command Center)**
 - Even manages home and Essential systems.
- **Free Evaluations of everything, including Hardware Appliances for business use.**
 - Evaluation hardware is easy to obtain for interested organizations.



Are you LinkedIn to Astaro?

<http://www.linkedin.com/e/gis/139679/189D6C60EC64>

Astaro on Facebook:

<http://www.facebook.com/pages/Astaro/107041096353>



astARO
internet security

Simplifying Email, Web & Network Protection

Thank you

www.astaro.com

jdaniel@astaro.com